

T-33 SHOOTING STAR USER MANUAL

Wingspan:1350mm

Length:1200mm

Empty Weight:2280G[w/o Battery]



- 1 Introduction
- 2 Product basic information
- 2 Package list
- PNP Assembly instructions
- 3 Install horizontal stabilizer
- 3 Install vertical stabilizer
- 3 Install main wing
- 4 Install other accessories
- 4 Install battery
- 5 Pushrod instructions
- 5 Center of Gravity
- PNP Parameter setting
- 6 Control direction test
- 7 Dual rates
- 7 Flap-to-Elevator Mix
- Pre-installed component overview
- 8 Servo direction
- 8 Motor specification

We are proud to announce the Freewing T-33 Shooting Star in 1/9.5 scale with a 1200mm length and generous 1350mm wingspan! Honoring the popular T-33 that flew with over 40 countries between 1948 and 2017, the Freewing T-33 faithfully represents this amazing aircraft.

Constructed from EPO foam, carbon, wood, aluminum, and other materials, the Freewing T-33 is powered by an 80mm EDF power system optimized for performance and easy flying behavior. Its wide wingspan and light wingloading allows for very stable flight behavior and a mild, gentle stall. Flaps and suspension landing gear make taking off from and landing on grass runways an easy operation. Removable tip tanks, an accurate overall outline, and landing gear doors enhance the scale fidelity of this model aircraft. Screw-together assembly is quick and convenient for modelers wanting to fly quickly!

The Freewing T-33's power system provides performance that is similar to other recent 80mm Freewing jets such as the popular Avanti S. The 100A ESC provides ample headroom for high power use, and the 80mm power system is proven across thousands of Freewing jets worldwide. Rapid acceleration, low cruising throttle position, and efficient energy consumption are key features of the Freewing T-33. Although its wingspan is greater than more expensive 90mm jets, the T-33 is affordable to operate and makes the perfect EDF trainer jet for new jet pilots moving up from smaller 64mm and 70mm jets.

With the recommended 6s 5000mAh lipo battery, the T-33 can achieve comfortable speeds approaching 180kph/110mph in level flight.

⚠ NOTE: This is not a toy. Not for children under 14 years. Young people under the age of 14 should only be permitted to operate this model under the instruction and supervision of an adult. Please keep these instructions for further reference after completing model assembly.

Note:

- 1.This is not a toy! Operator should have a certain experience, beginners should operate under the guidance of professional players.
- 2.Before install, please read through the instructions carefully and operate strictly under instructions.
- 3.Cause of wrong operation, Freewing and its vendors will not be held responsible for any losses.
- 4.Model planes' players must be on the age of 14 years old.
- 5.This plane used the EPO material with surface spray paint, don't use chemical to clean, otherwise it will damage.
- 6.You should be careful to avoid flying in areas such as public places, high-voltage-intensive areas, near the highway, near the airport or any other place where laws and regulation clearly prohibit.
- 7.You cannot fly in bad weather conditions such as thunderstorms, snows....
- 8.Model plane's battery, don't allowed to put in everywhere. Storage must ensure that there is no inflammable and explosive materials in the round of 2M range.
- 9.Damaged or scrap battery should be properly recycled, it can't discard to avoid spontaneous combustion and fire.
- 10.In flying field, the waste after flying should be properly handled, it can't be abandoned or burned.
- 11.In any case, you must ensure that the throttle is in the low position and transmitter switch on, then it can connect the lipo-battery in aircraft.
- 12.Do not try to take planes by hand when flying or slow landing process. You must wait for landing stop, then carry it.

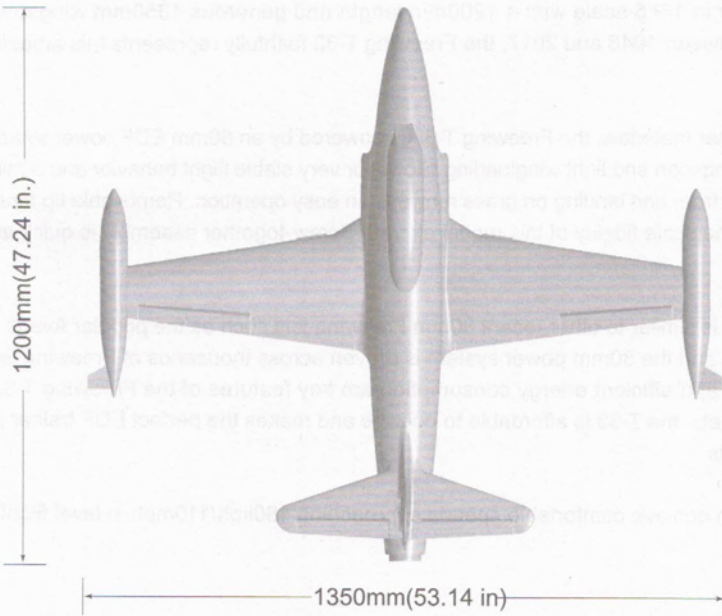

Standard Version

Wingload: 113 g/dm²
 Wing Area: 25 dm²
 Motor: 3658-1920KV I/R Motor
 Servo: 9g Hybrid digital servo (8pcs)
 ESC: 100A with 5A BEC
 Ducted fan: 80mm 9-blade fan
 Weight: 2280g (w/o Battery)

Other features

Material: EPO
 Aileron: Yes Flap: Yes
 Elevator: Yes Rudder: Yes
 Landing gear: Electric Landing Gear
 Cabin door: Nose gear cabin door
 Scale LED lights
 Scale Pilot figure
 Li-Po Battery: 6S 4000-6000mAh (1pcs)

Note: The parameters in here are derived from test result using our accessories. If use other accessories, the test result will be different. Any problem since of using other accessories, we are not able to provide technical support.

Package List

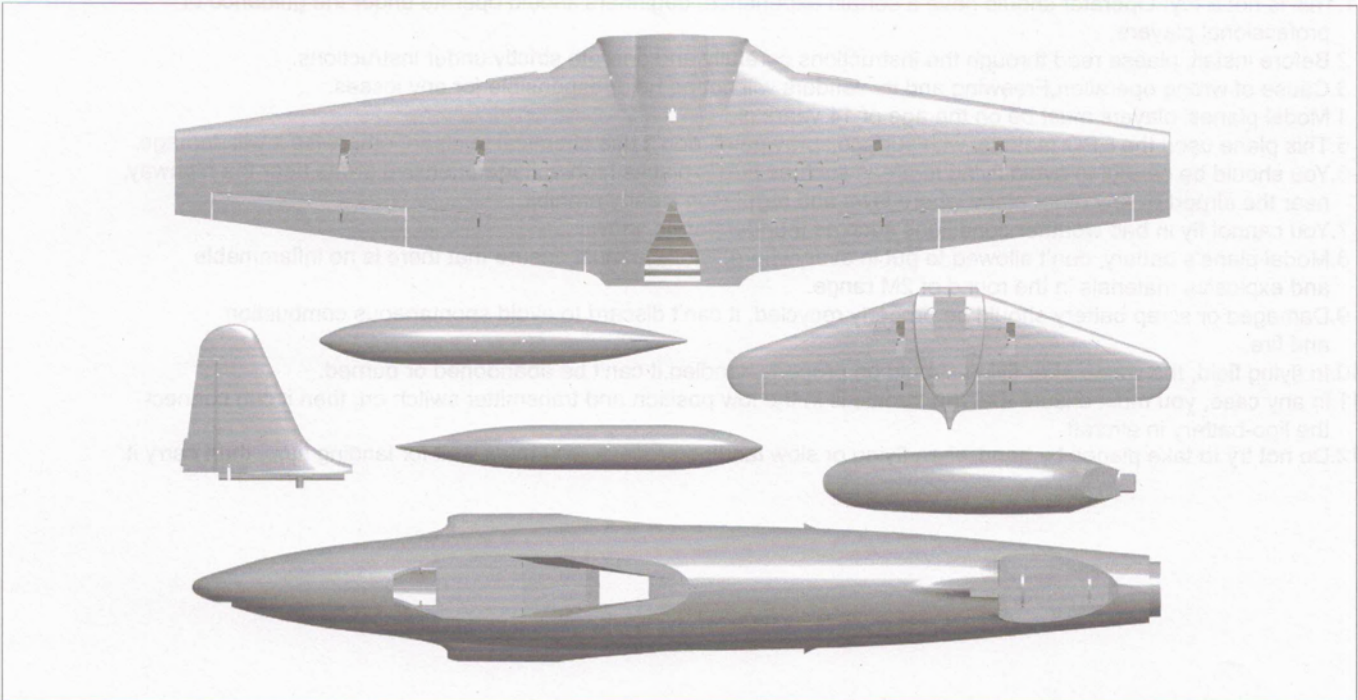

Different equipment include different spareparts. Please refer to the following contents to check your sparepart list.

No.	Name	PNP	ARF Plus
1	Fuselage	Pre-installed all electronic parts	Pre-installed servo
2	Main wing	Pre-installed all electronic parts	Pre-installed servo
3	Horizontal tail	Pre-installed all electronic parts	Pre-installed servo
4	Vertical tail	Pre-installed all electronic parts	Pre-installed servo
5	Fuel tank	✓	✓

No.	Name	PNP	ARF Plus
6	Manual	✓	✓
7	Pushrod	✓	✓
8	Non-slipmat	✓	✓
9	Screw	✓	✓

Install Horizontal Stabilizer

Screws : FA3×10mm 2pcs

- 1.Insert the traction steel wire from the battery compartment to the tail.
- 2.As the photo show, use the traction steel wire to pull the servo cable back, and install the horizontal stabilizer to the indicated position of tail fuselage,
- 3.Use 2pcs screws to fix the horizontal stabilizer

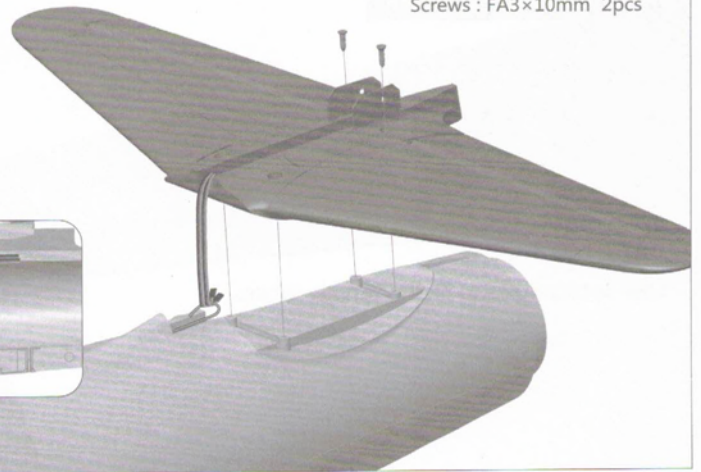
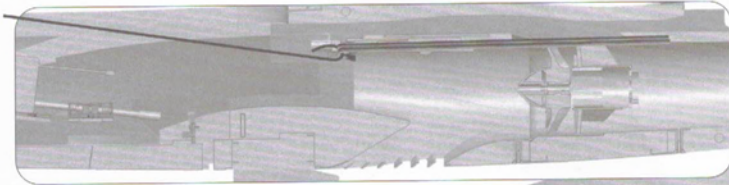

Install Vertical Stabilizer

- 1.Insert the traction steel wire from the battery compartment to the tail.
- 2.As the photo show, use the traction steel wire to pull the servo cable back, and install the vertical stabilizer to the indicated position of tail fuselage.
- 3.Use 4pcs screws to fix the vertical stabilizer.

Screws : FA3×10mm 4pcs

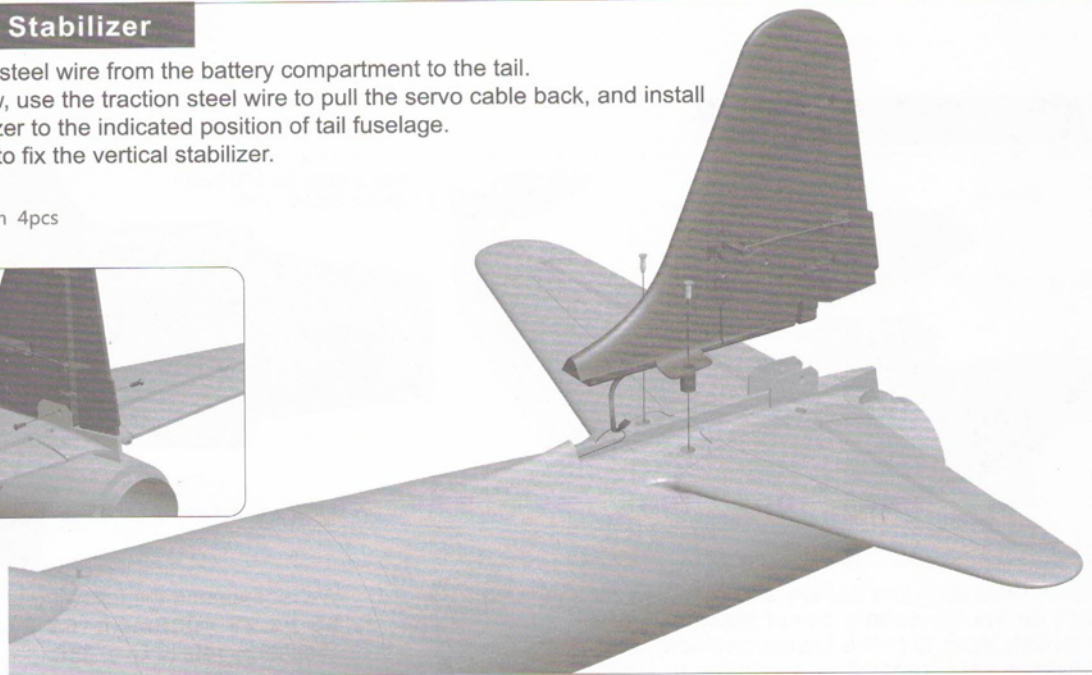

Install Main wing

As the photo show:

- 1.Insert the ribbon wire to the main wing control board.
- 2.Install the main wing on the fuselage and use 4pcs screws to fix.

A-Ribbon wire
B-Main wing control board

Screws : PM3×8mm 4pcs

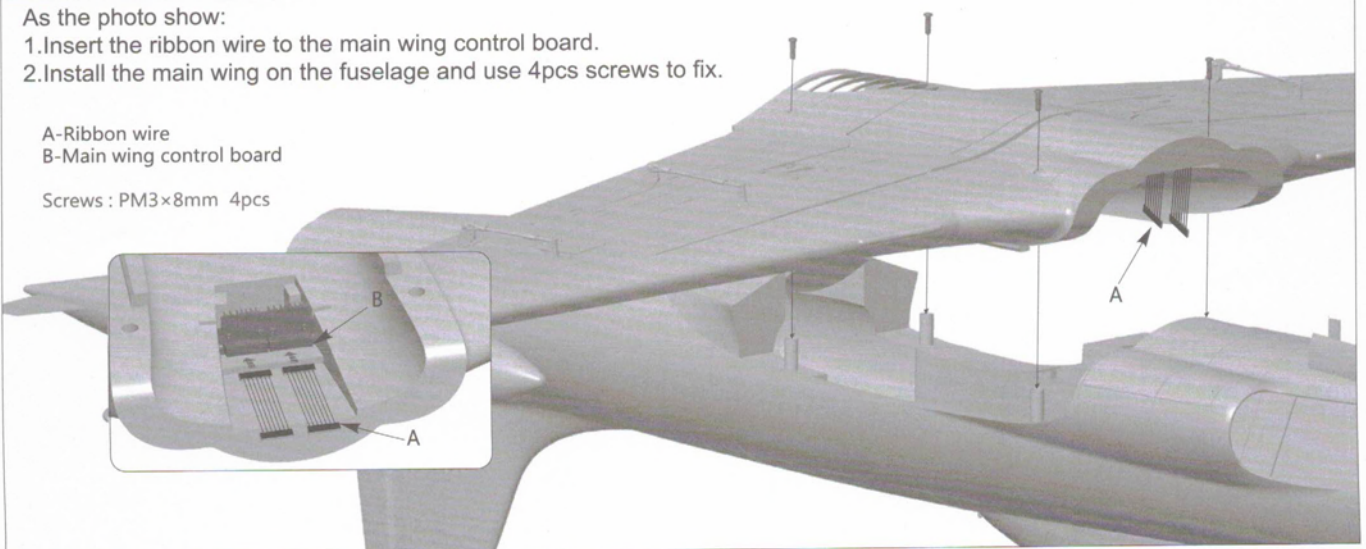
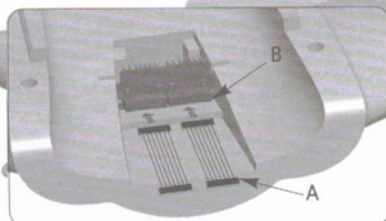

Install Wingtip tank

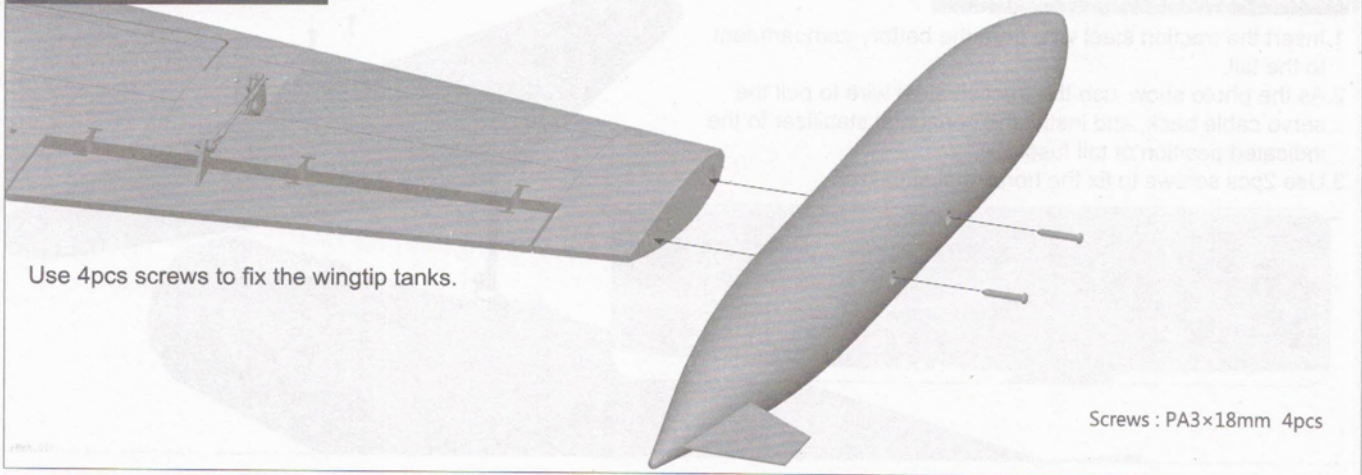

Install Battery

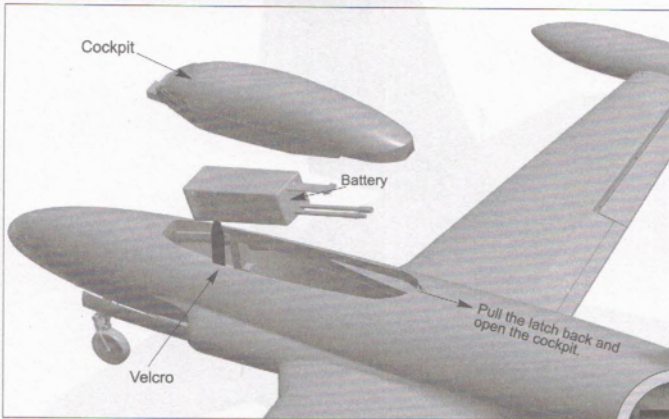







Before connecting the battery and receiver, please switch on the transmitter power and make sure the throttle stick is in the lowest position. Bind your receiver to your transmitter according to your transmitter's instruction manual.

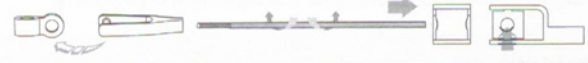

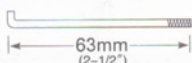
We recommend the following LiPo battery:
6S 22.2V 4000mAh~6S 22.2V 5000mAh
 Discharge rate of C ≥ 35C

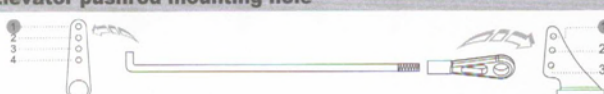
Pushrod instructions

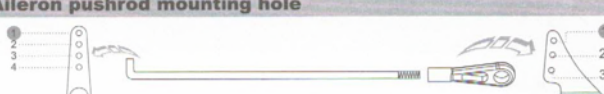
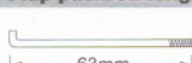
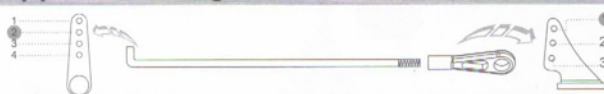
<p>Nose gear steering pushrod length</p>  <p>55mm (2-3/16")</p> <p>Pushrod diameter Ø1.2mm</p>	<p>Nose gear steering pushrod mounting hole</p> 
<p>Nose cabin door pushrod length</p>  <p>24mm (1")</p> <p>Pushrod diameter Ø1.2mm</p>	<p>Aileron pushrod mounting hole</p> 
<p>Rudder pushrod length</p>  <p>63mm (2-1/2")</p> <p>Pushrod diameter Ø1.5mm</p>	<p>Rudder pushrod mounting hole</p> 
<p>Elevator pushrod length</p>  <p>48mm (1-13/16")</p> <p>Pushrod diameter Ø1.5mm</p>	<p>Elevator pushrod mounting hole</p> 
<p>Aileron pushrod length</p>  <p>63mm (2-1/2")</p> <p>Pushrod diameter Ø1.5mm</p>	<p>Aileron pushrod mounting hole</p> 
<p>Flap pushrod length</p>  <p>63mm (2-1/2")</p> <p>Pushrod diameter Ø1.5mm</p>	<p>Flap pushrod mounting hole</p> 

Center of Gravity

Correct Center of Gravity ("CG") is critical for enabling safe aircraft stability and responsive control. Please refer to the following CG diagram to adjust your aircraft's Center of Gravity.

- Depending on the capacity and weight of your chosen flight batteries, move the battery forward or backward to adjust the Center of Gravity.
- If you cannot obtain the recommended CG by moving the battery to a suitable location, you can also install a counterweight to achieve correct CG. However, with the recommended battery size, a counterweight is not required. We recommend flying without unnecessary counterweight.

As the photo show, We marked the center of gravity on the bottom of the fuselage. Please confirm the CG based on this marked position.

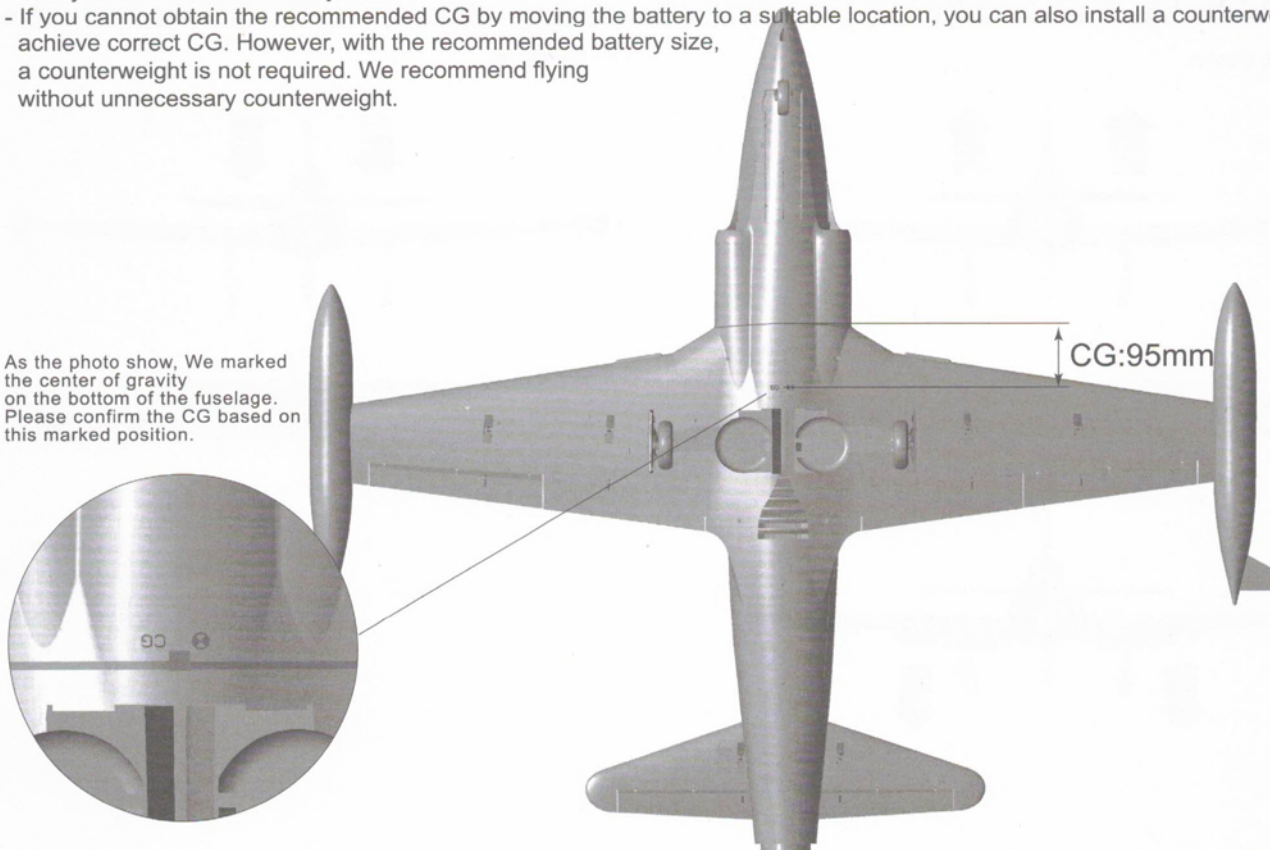

Control Direction Test

After installed the plane, before flying, we need a fully charged battery and connect to the ESC, then use radio to test and check that every control surface work properly.

Aileron

Stick Left

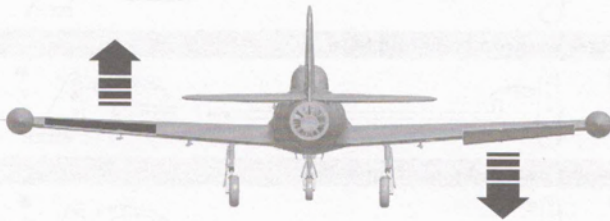

Stick Right

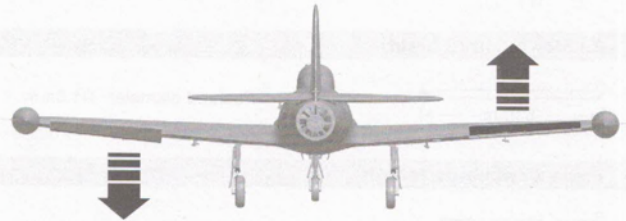

Rudder

Stick Left

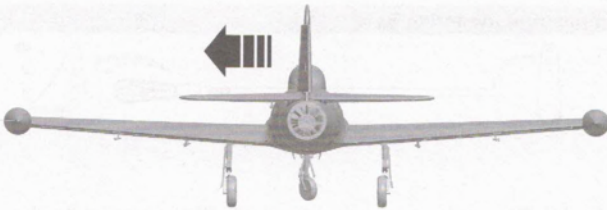

Stick Right

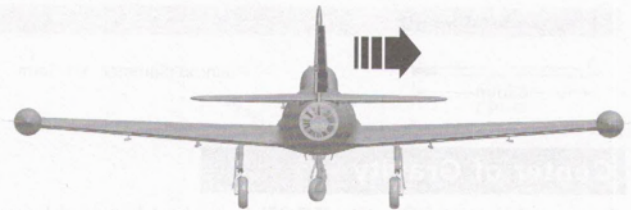

Elevator

Stick down

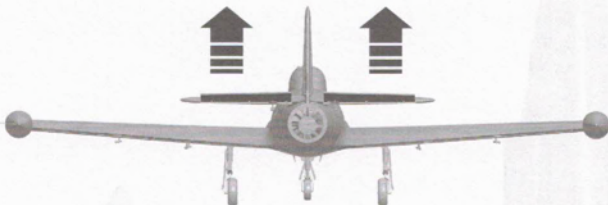

Stick up

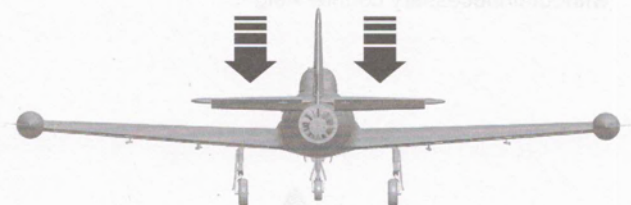

Flaps

Flaps down

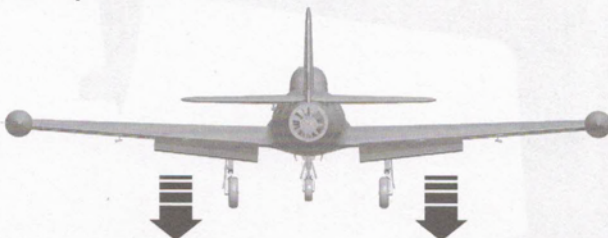

Dual Rates

According to our testing experience, use the following parameters to set Aileron/Elevator Rate. Program your preferred Exponential % in your radio transmitter. We recommend using High Rate for the first flight, and switching to Low Rate if you desire a lower sensitivity. On successive flights, adjust the Rates and Expo to suit your preference.

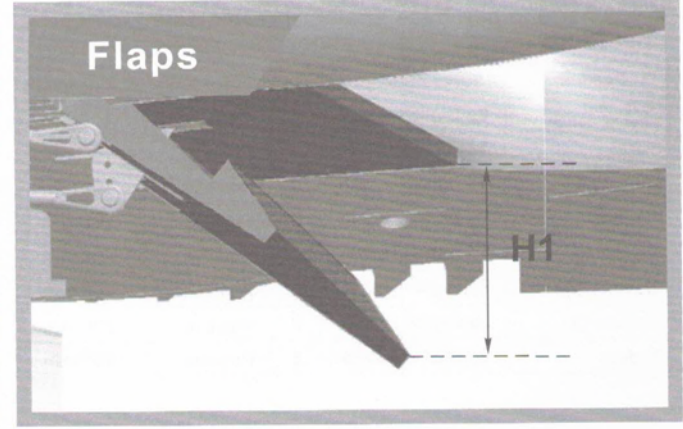
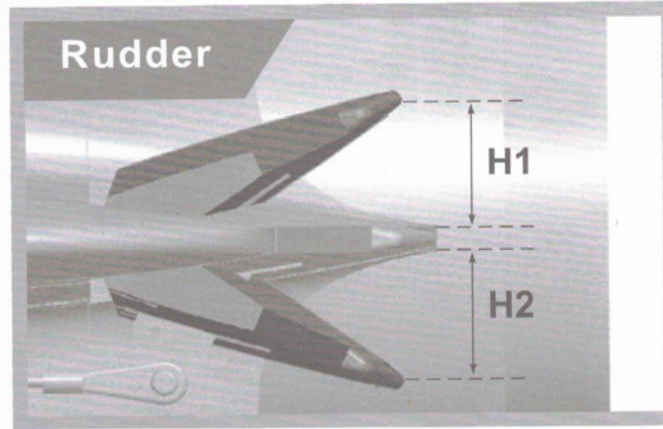
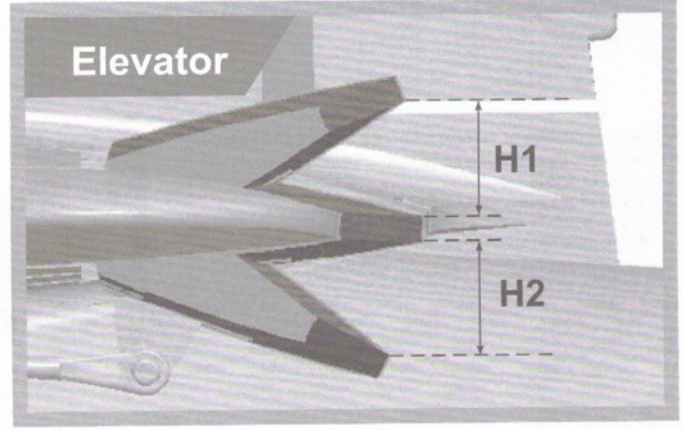
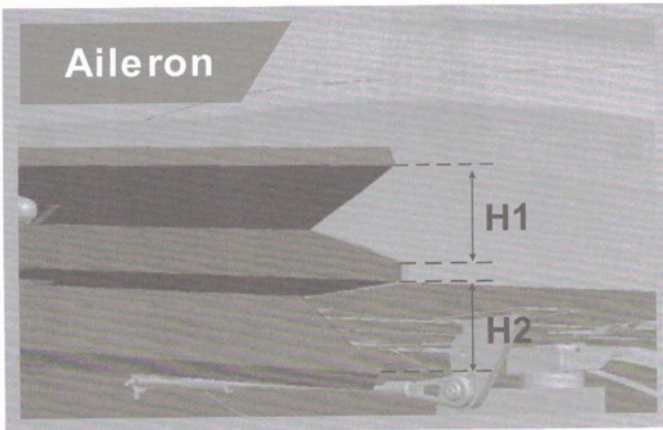

	Aileron (Measured closest to the fuselage)	Elevator (Measured closest to the fuselage)	Rudder (Measured from the bottom)	Flaps
Low Rate	H1/H2 18mm/18mm D/R Rate : 85%	H1/H2 18mm/18mm D/R Rate : 85%	H1/H2 19mm/19mm D/R Rate : 85%	H1 16mm
High Rate	H1/H2 20mm/20mm D/R Rate : 100%	H1/H2 20mm/20mm D/R Rate : 100%	H1/H2 24mm/24mm D/R Rate : 100%	H1 30mm

Flap-to-Elevator Mix

A Flap-to-Elevator Mix is required to maintain level flight when the flaps are deployed. The detail is as below:

- With low rate flaps deployed, mix 0.5mm (1.5%) of DOWN elevator to maintain level flight.
- With high rate flaps deployed, mix 1mm (3%) of DOWN elevator to maintain level flight.

Or

Trim the elevator DOWM 3 times (low rate) or 6 times (high rate) when the FLAP are deployed.

Servo Direction

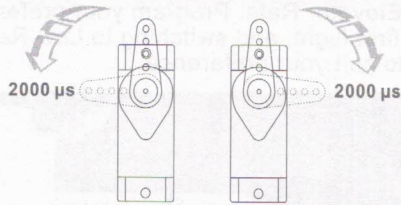

The servo positive or reverse rotation is defined as follows:
 When servo input signal change from 1000μs to 2000μs,
 The servo arm is **rotated clockwise**, its **positive servo**.
 The servo arm is **rotated counterclockwise**, its **reverse servo**.

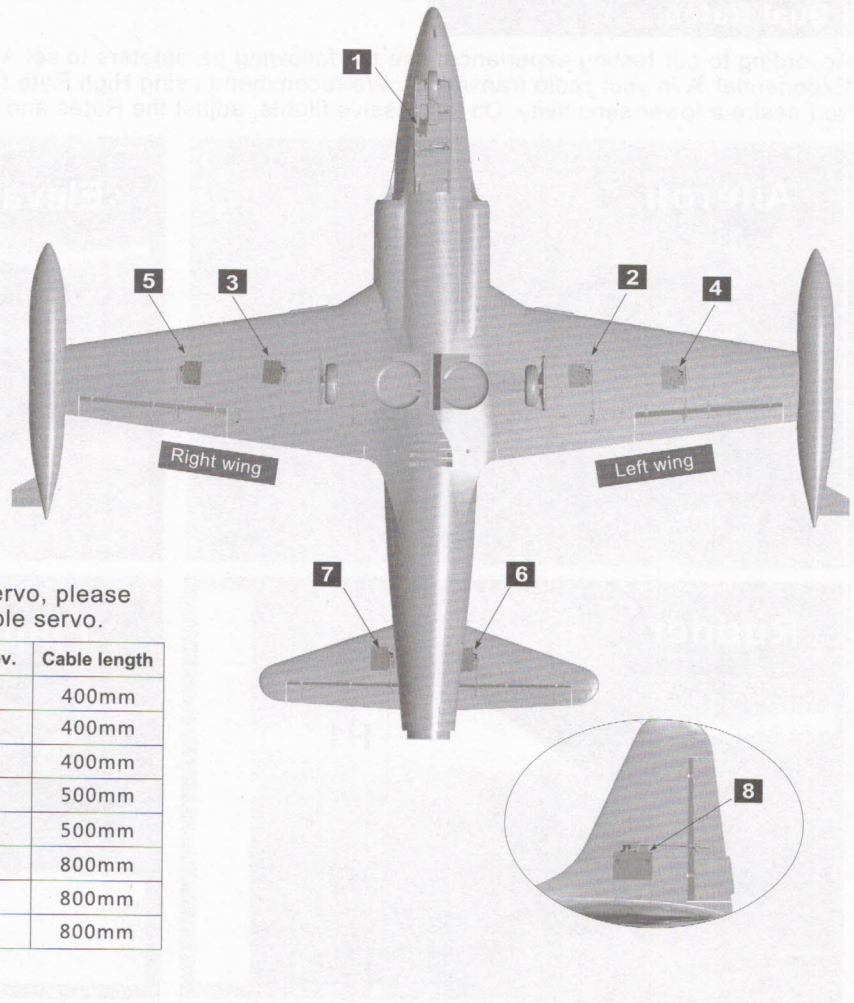

If you need to purchase another brand's servo, please refer to the following list to choose a suitable servo.

Position	Servo regulation	No.	Pos. / Rev.	Cable length
Nose gear steering servo	9g Digital-Hybrid	1	Positive	400mm
Flap(L)	9g Digital-Hybrid	2	Positive	400mm
Flap(R)	9g Digital-Hybrid	3	Positive	400mm
Aileron(L)	9g Digital-Hybrid	4	Positive	500mm
Aileron(R)	9g Digital-Hybrid	5	Positive	500mm
Elevator(L)	9g Digital-Hybrid	6	Positive	800mm
Elevator(R)	9g Digital-Hybrid	7	Positive	800mm
Rudder	9g Digital-Hybrid	8	Positive	800mm

Motor Specification

#MOI36584
 3658-1920KV

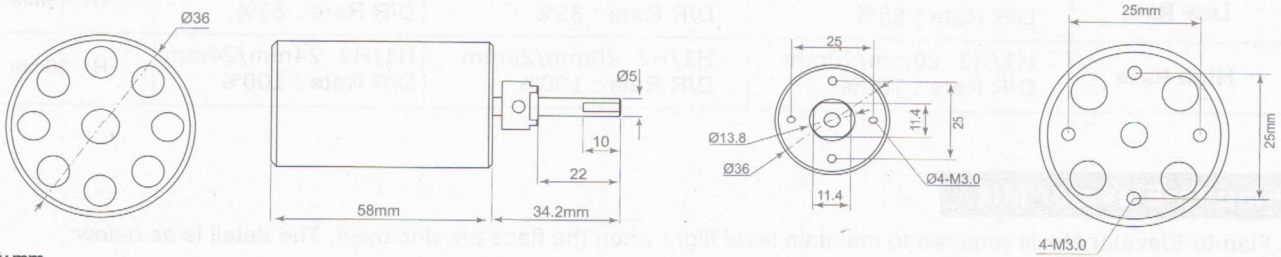

Unit:mm

Item No.	Fan size	Motor specifications	Voltage (V)	Current (A)	Max power (W)	Thrust (g)	Efficiency (g/w)	Speed (rpm)	Weight (g)
E72313	80mm 9-Blade	3658-1920KV	22.2	90	2000	3400	1.7	42000	345

